



Pacifico Lapo Ciatti, 2022

IT Libreria modulare a giorno in acciaio. Disponibile in quattro versioni.
È possibile realizzare configurazioni di grandi dimensioni per accostamento.
Richiede fissaggio a parete. Piedini regolabili.

KIT A: composto da 14 mensole. Prevede il posizionamento dei libri in orizzontale.

KIT B: composto da 7 mensole e 14 fermalibri.

KIT SHELF A: composto da 6 mensole e ripiano scrivania in pietra acrilica.

Prevede il posizionamento dei libri in orizzontale.

KIT SHELF B: composto da 3 mensole, 6 fermalibri e un ripiano scrivania in pietra acrilica.

Finiture mensole, montanti e fermalibri: bianco opaco RAL 9016.

Finiture scrivania: bianco.

EN Modular open bookcase in steel. Available in four versions. Large configurations are possible by combining modules. Requires wall fixing. Adjustable feet.

KIT A: 14 shelves. Designed for books to be placed horizontally.

KIT B: 7 shelves and 14 bookends.

KIT SHELF A: 6 shelves and a desk shelf in acrylic stone. Designed for books to be placed horizontally.

KIT SHELF B: 3 shelves, 6 bookends, and a desk shelf in acrylic stone.

Shelf, upright and bookend finishes: matt white RAL 9016.

Desk finishes: white.

FR Bibliothèque modulaire ouverte en acier. Disponible en quatre versions.

Possibilité de réaliser des configurations de grandes tailles pour assemblages. La fixation au mur est indispensable. Pieds réglables.

KIT A : composé de 14 étagères. Disposition des livres à l'horizontale.

KIT B : composé de 7 étagères et 14 serre-livres.

KIT SHELF A : composé de 6 étagères et un plateau pour bureau en pierre acrylique. Disposition des livres à l'horizontale.

KIT SHELF B : composé de 3 étagères, 6 serre-livres et un plateau pour bureau en pierre acrylique.

Finitions étagères, montants et serre-livres : blanc mat RAL 9016.

Finitions bureau : blanc.

DE Modulares offenes Bücherregal aus Stahl. Erhältlich in vier Versionen. Durch die Kombination mehrerer Regale lassen sich Konfigurationen mit großen Abmessungen schaffen. Eine Befestigung des Regals an der Wand ist erforderlich. Verstellbare Füßchen.

KIT A: mit 14 Regalböden. Sieht vor, dass die Bücher im Regal liegen.

KIT B: mit 7 Regalböden und 14 Buchstützen.

KIT SHELF A: mit 6 Regalböden und Schreibtischplatte aus Acrylstein. Sieht vor, dass die Bücher im Regal liegen.

KIT SHELF B: mit 3 Regalböden, 6 Buchstützen und einer Schreibtischplatte aus Acrylstein.

Ausführungen Regalböden, Pfosten und Buchstützen: Mattweiß RAL 9016.

Ausführungen Schreibtischplatte: Weiß.

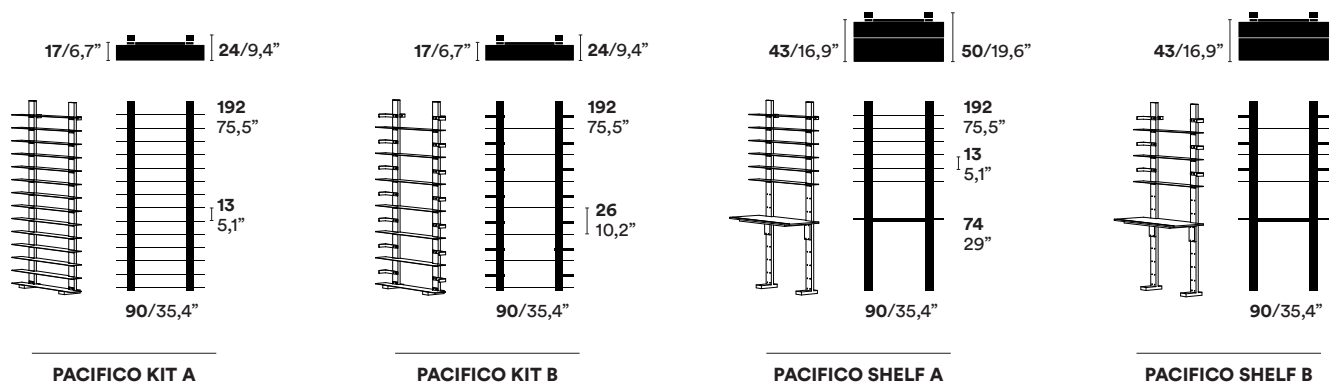
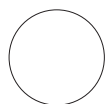

Note

Capacità approssimativa: KIT A 280 volumi, KIT B 250 volumi, KIT SHELF A 200 volumi, KIT SHELF B 100 volumi.
Capacity approx: KIT A 280 volumes, KIT B 250 volumes, KIT SHELF A 200 volumes, KIT SHELF B 100 volumes.
Capacité environ: KIT A 280 volumes, KIT B 250 volumes, KIT SHELF A 200 volumes, KIT SHELF B 100 volumes.
Fasst circa: KIT A 280 Bücher, KIT B 250 Bücher, KIT SHELF A 200 Bücher, KIT SHELF B 100 Bücher.

La portata massima di ogni mensola è 15 kg.
Max. load per shelf: 15 kg.
Max. charge par tablette : 15 kg.
Belastung pro Regalboden: 15 kg.

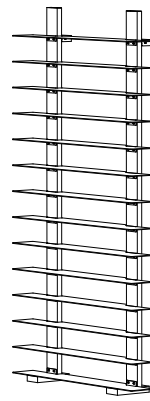

KIT A

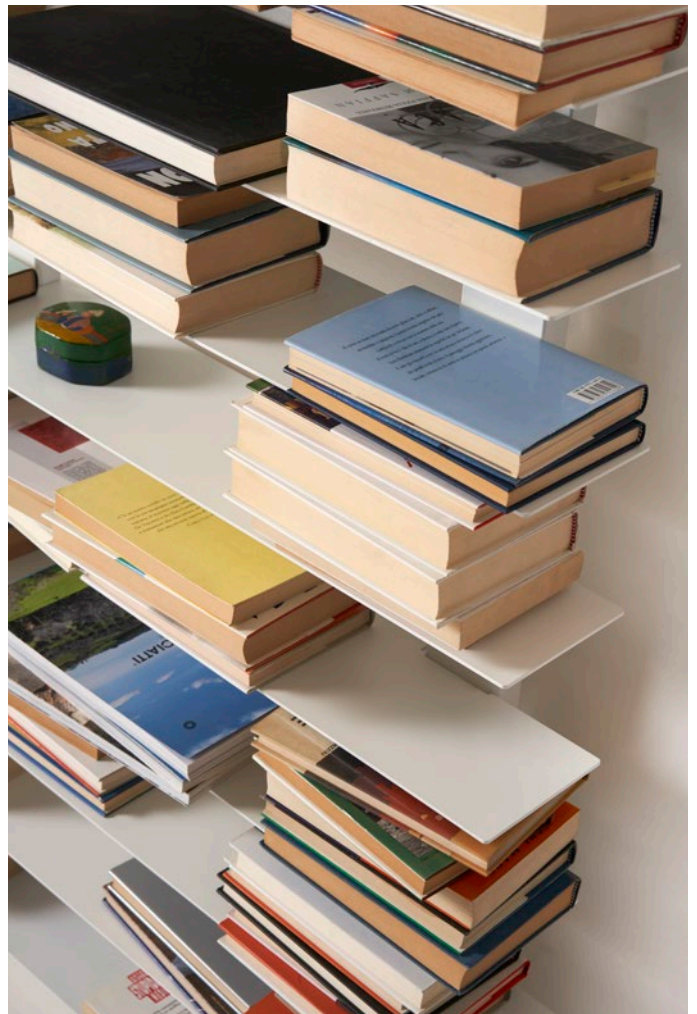

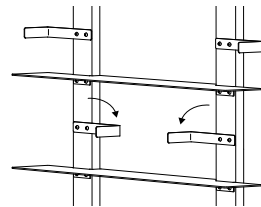
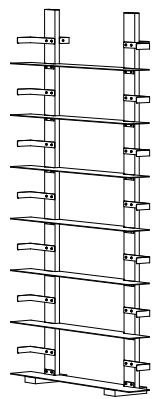
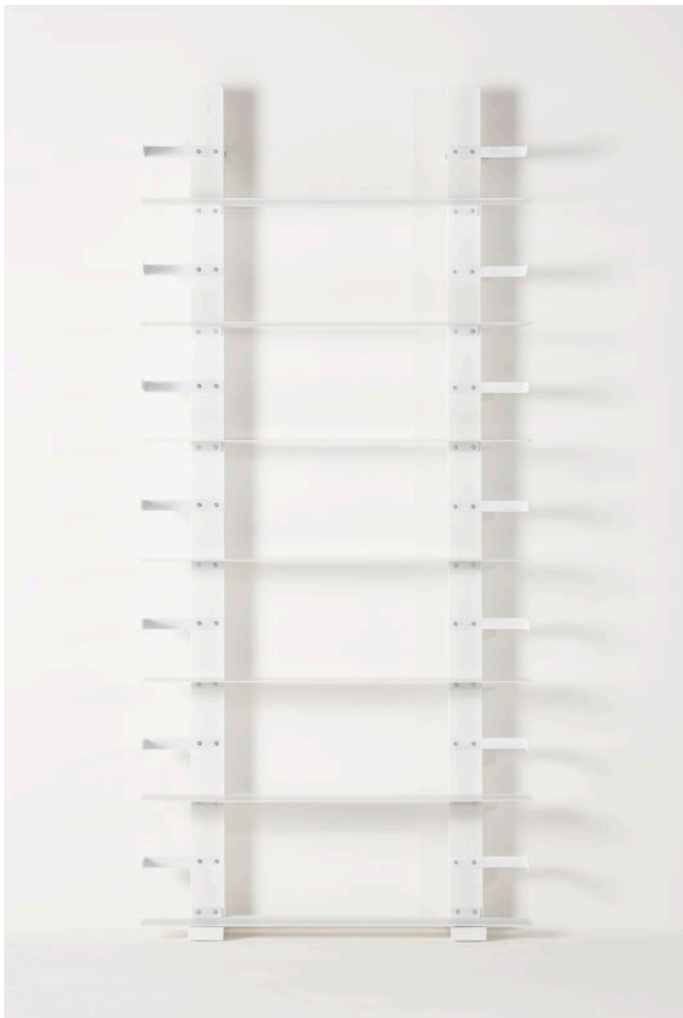

I fermalibri possono essere capovolti.
The bookends can be turned upside down.
Les serre-livres peuvent être retournés.
Die Buchstützen können umgedreht werden.

KIT B



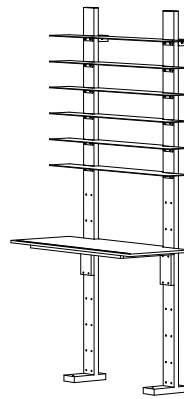

KIT SHELF A

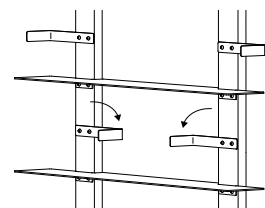
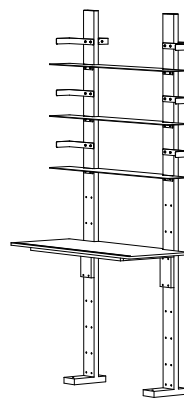

KIT SHELF B

I fermalibri possono essere capovolti.
 The bookends can be turned upside down.
 Les serre-livres peuvent être retournés.
 Die Buchstützen können umgedreht werden.